

Agilent Technologies 8712E Series RF Vector Network Analyzers

Technical Specifications

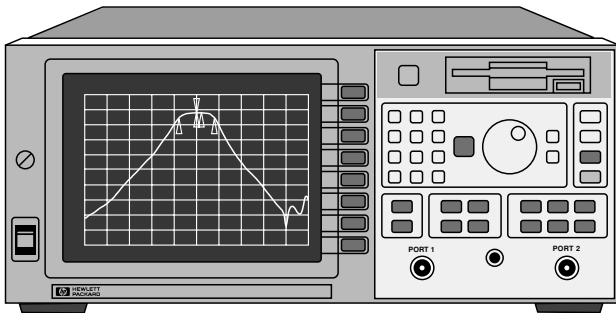
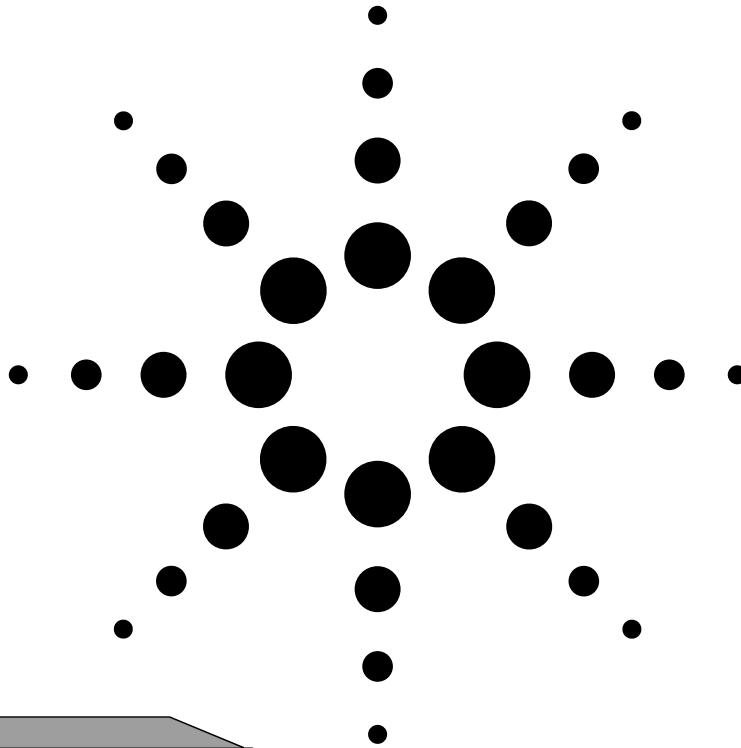

8712ET and 8712ES 300 kHz to 1.3 GHz **8714ET and 8714ES** 300 kHz to 3.0 GHz

This document describes the performance and features of Agilent's 50 and 75 ohm 8712E series RF vector network analyzers:

- *8712ET* transmission/reflection vector network analyzer, 300 kHz to 1.3 GHz
- *8712ES* S-parameter vector network analyzer, 300 kHz to 1.3 GHz
- *8714ET* transmission/reflection vector network analyzer, 300 kHz to 3.0 GHz
- *8714ES* S-parameter vector network analyzer, 300 kHz to 3.0 GHz

For more information about these analyzers, please read the following documents:

- 8712E Series Brochure: 5967-6316E
- 8712E Series Configuration Guide: 5967-6315E



Agilent Technologies
Innovating the HP Way

Introduction

All specifications and characteristics apply over a 25° C ±5° C range (unless otherwise stated) and 60 minutes after the instrument has been turned on.

Definitions

Specifications: Warranted performance. Specifications include guardbands to account for the expected statistical distribution, measurement uncertainties, and changes in performance due to environmental conditions.

Characteristics: A performance parameter that the product is expected to meet before it leaves the factory, but is not verified in the field, and is not covered by the product warranty. A characteristic includes the same guardbands as a specification.

Typical: Expected performance of an average instrument which does not include guardbands. It is not covered by the instrument's warranty.

Nominal: A general, descriptive term that does not imply a level of performance. It is not covered by the instrument's warranty.

Supplemental information: may include typical, nominal or characteristic values.

Calibration is the process of measuring known standards from a calibration kit to characterize a network analyzer's systematic (repeatable) errors.

Corrected (residual) performance: Indicates performance after error correction (calibration). It is determined primarily by the quality of the calibration standards and how well "known" they are, plus the effects of system repeatability, stability, and noise.

Uncorrected (raw) performance: Indicates performance without error correction (calibration). Uncorrected performance affects the stability of a calibration — the better the raw performance, the more stable the calibration.

Table of contents

System performance, two-port calibration	3
System performance, T/R calibration	8
System performance, uncorrected	14
Test port output	15
Test port input	17
General information	22
Block diagrams	26
Product features	27

System Performance, 2-Port Calibration (7-mm, 50 Ω)

8712ES/8714ES 85031B (7-mm, 50 Ω) Cal Kit, User 2-Port Calibration		
Description	Specification ^a (in dB)	
	300 kHz to 1.3 GHz	1.3 GHz to 3 GHz
Directivity	55	51
Source Match	51	49
Load Match	55	51
Reflection Tracking	±0.012	±0.005
Transmission Tracking	±0.033	±0.035

Transmission Uncertainty (Specification)^{a,b}

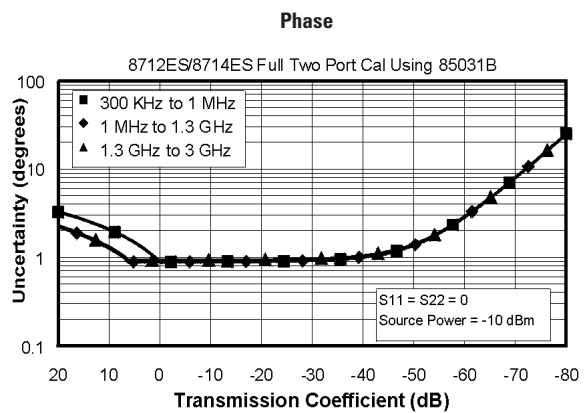
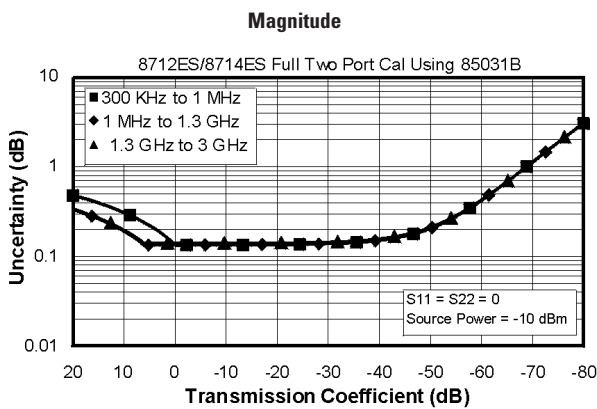

Reflection Uncertainty (Specification)^a

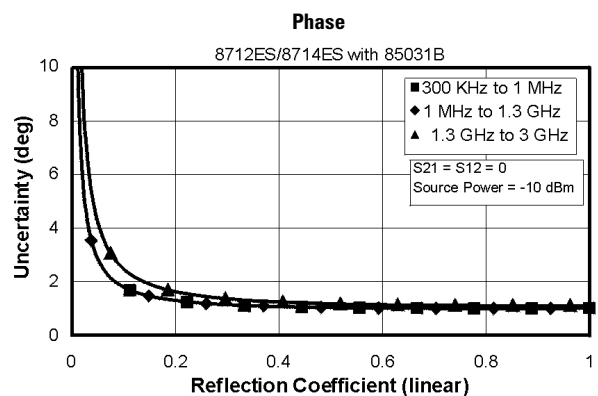
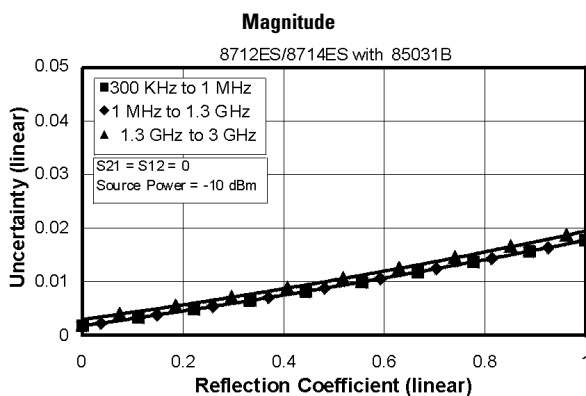

- a. These specifications apply for measurements made using the “fine” (15 Hz) bandwidth, no averaging, and at an ambient temperature of 25° ±5° C, with less than 1° C deviation from the calibration temperature.
- b. For transmission measurements, the effect of crosstalk is disregarded and $S_{12}=S_{21}$ for $S_{21} < 1.0$, $S_{12}=1/S_{21}$ for $S_{21} > 1.0$

System Performance, 2-Port Calibration (Type-N, 50 Ω)

8712ES/8714ES 85032B/E (Type-N, 50 Ω) Cal Kit, User 2-Port Calibration		
Description	Specification ^a (in dB)	
	300 kHz to 1.3 GHz	1.3 GHz to 3 GHz
Directivity	50	47
Source Match	42	36
Load Match	50	47
Reflection Tracking	±0.02	±0.02
Transmission Tracking	±0.04	±0.055

Transmission Uncertainty (Specification)^{a,b}

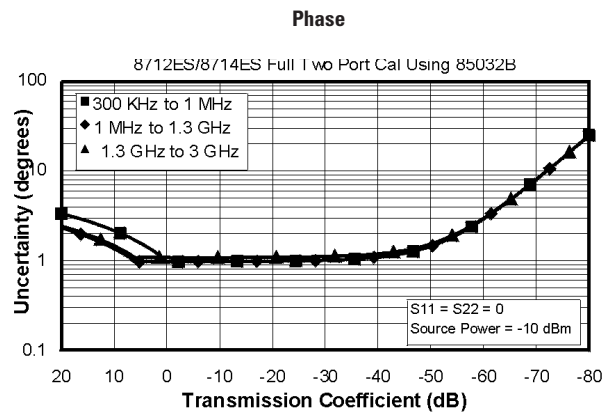
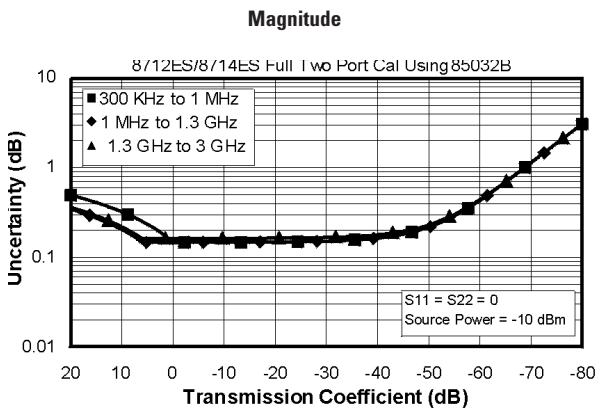

Reflection Uncertainty (Specification)^a

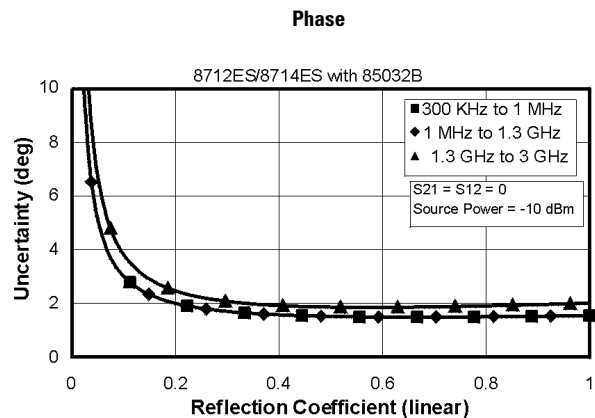
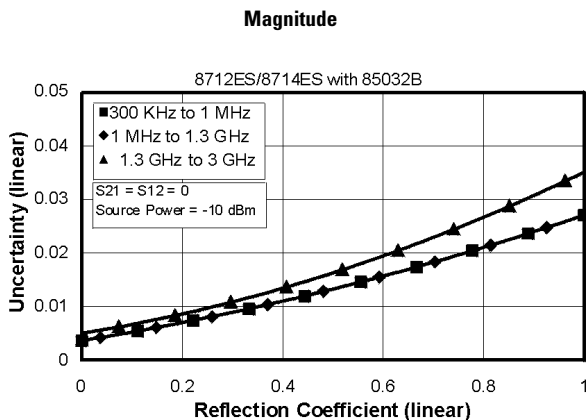

- a. These specifications apply for measurements made using the “fine” (15 Hz) bandwidth, no averaging, and at an ambient temperature of $25^\circ \pm 5^\circ \text{C}$, with less than 1°C deviation from the calibration temperature.
- b. For transmission measurements, the effect of crosstalk is disregarded and $S_{12}=S_{21}$ for $S_{21} < 1.0$, $S_{12}=1/S_{21}$ for $S_{21} > 1.0$

System Performance, 2-Port Calibration (3.5 mm, 50 Ω)

8712ES/8714ES 85033D (3.5 mm, 50 Ω) Cal Kit, User 2-Port Calibration		
Description	Specification ^a (in dB)	
	300 kHz to 1.3 GHz	1.3 GHz to 3 GHz
Directivity	46	43
Source Match	44	41
Load Match	46	43
Reflection Tracking	±0.016	±0.008
Transmission Tracking	±0.04	±0.05

Transmission Uncertainty (Specification)^{a,b}

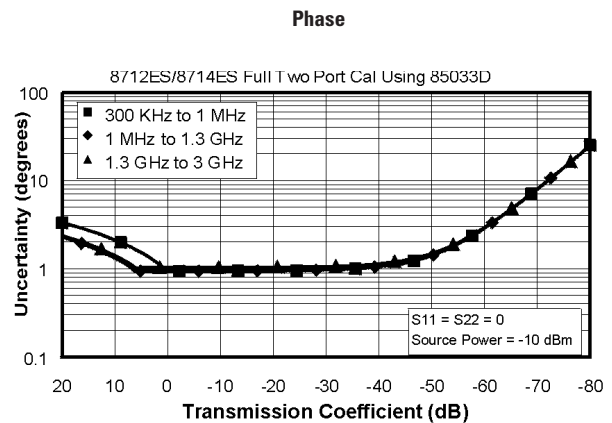
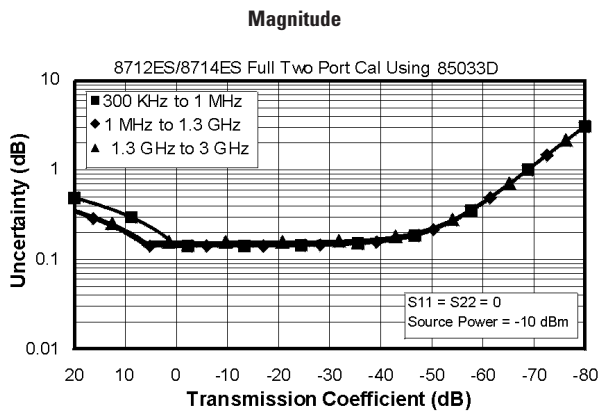

Reflection Uncertainty (Specification)^a

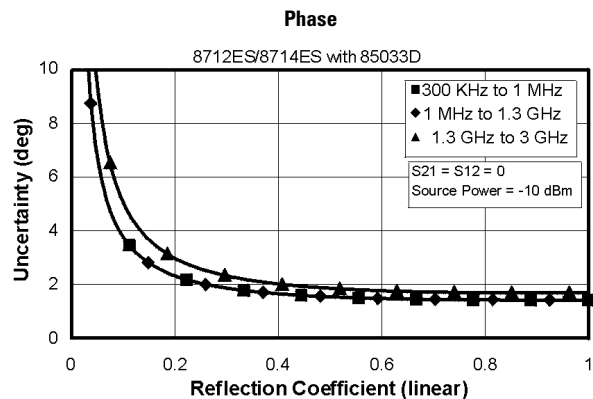
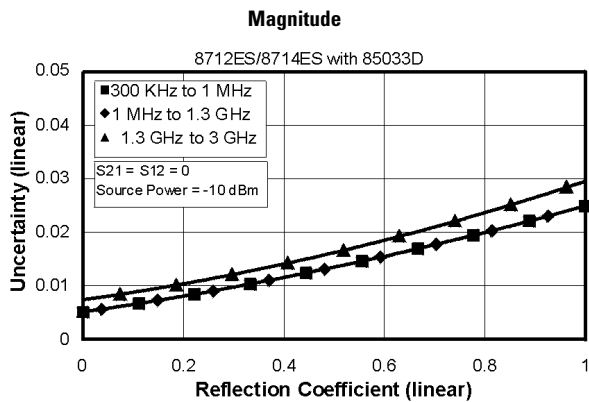

- a. These specifications apply for measurements made using the “fine” (15 Hz) bandwidth, no averaging, and at an ambient temperature of 25° ±5° C, with less than 1° C deviation from the calibration temperature.
- b. For transmission measurements, the effect of crosstalk is disregarded and $S_{12}=S_{21}$ for $S_{21} < 1.0$, $S_{12}=1/S_{21}$ for $S_{21} > 1.0$

System Performance, 2-Port Calibration (7-16, 50 Ω)

8712ES/8714ES 85038A (7-16, 50 Ω) Cal Kit, User 2-Port Calibration		
Description	Specification ^a (in dB)	
	300 kHz to 1.3 GHz	1.3 GHz to 3 GHz
Directivity	40	40
Source Match	37	37
Load Match	40	40
Reflection Tracking	±0.1	±0.09
Transmission Tracking	±0.054	±0.063

Transmission Uncertainty (Specification)^{a,b}

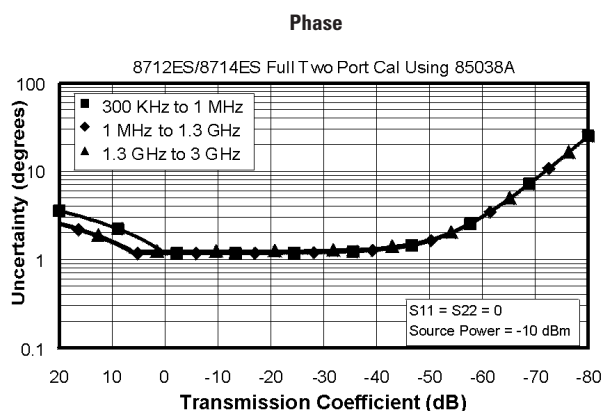
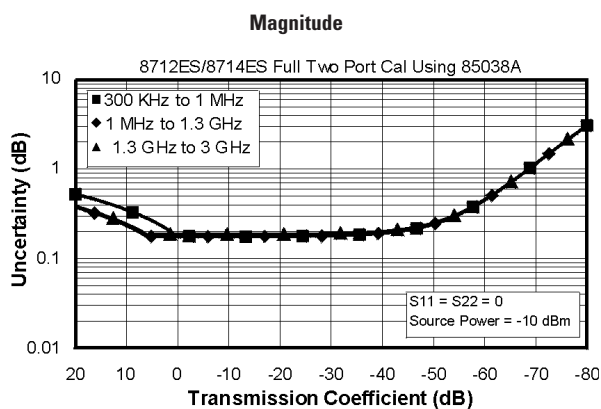

Reflection Uncertainty (Specification)^a

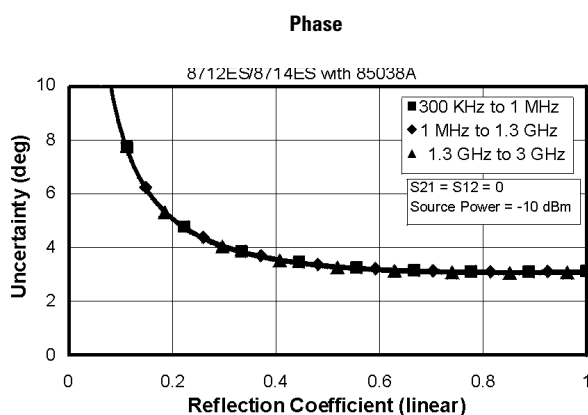
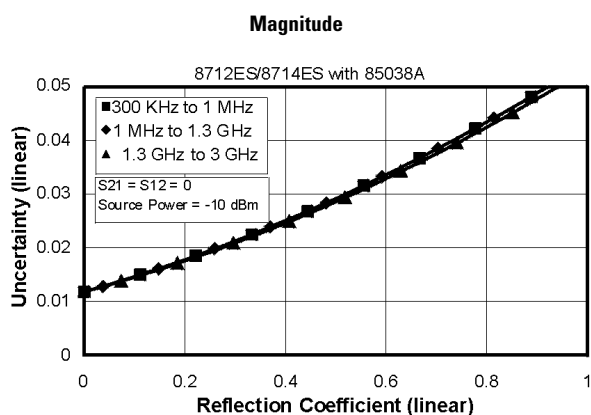

- a. These specifications apply for measurements made using the “fine” (15 Hz) bandwidth, no averaging, and at an ambient temperature of 25° ±5° C, with less than 1° C deviation from the calibration temperature.
- b. For transmission measurements, the effect of crosstalk is disregarded and $S_{12}=S_{21}$ for $S_{21} < 1.0$, $S_{12}=1/S_{21}$ for $S_{21} > 1.0$

System Performance, 2-Port Calibration (Type-N, 75 Ω)

8712ES/8714ES with Option 1EC ^a 85036B/E (Type-N, 75 Ω) Cal Kit, User 2-Port Calibration		
Description	Specification ^b (in dB)	
	300 kHz to 1.3 GHz	1.3 GHz to 3 GHz
Directivity	48	43
Source Match	41	35
Load Match	48	43
Reflection Tracking	±0.021	±0.02
Transmission Tracking	±0.042	±0.062

Transmission Uncertainty (Specification)^{b,c}

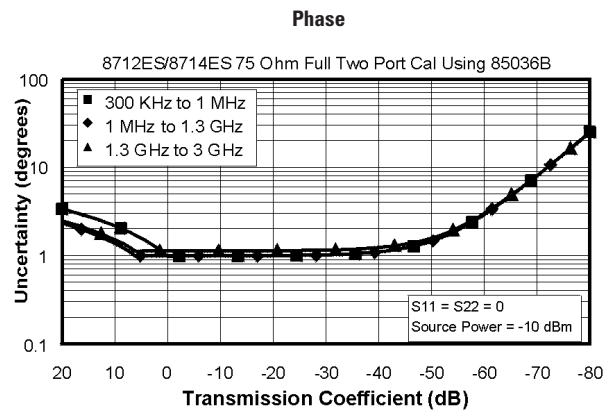
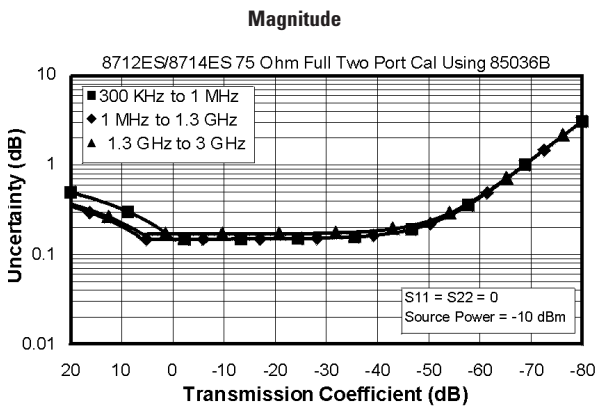

Reflection Uncertainty (Specification)^b

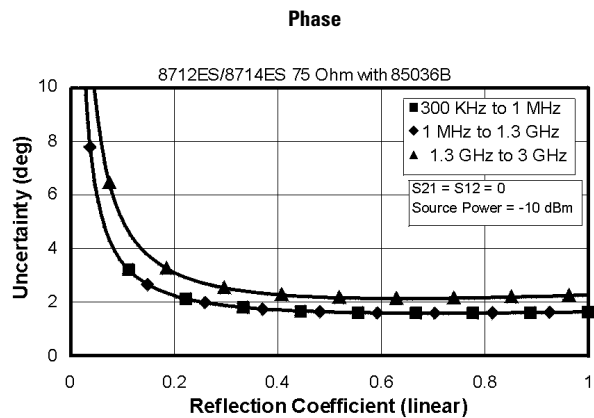
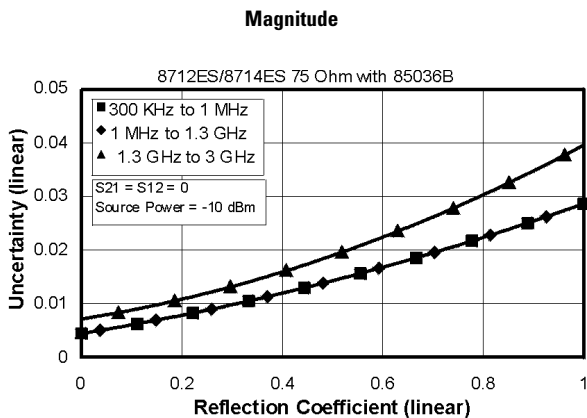

a. Option 1EC provides 75 Ω system impedance.

b. These specifications apply for measurements made using the “fine” (15 Hz) bandwidth, no averaging, and at an ambient temperature of 25° ±5° C, with less than 1° C deviation from the calibration temperature.

c. For transmission measurements, the effect of crosstalk is disregarded and $S_{12}=S_{21}$ for $S_{21} < 1.0$, $S_{12}=1/S_{21}$ for $S_{21} > 1.0$

System Performance, 2-Port Calibration (Type-F, 75 Ω)

8712ES/8714ES with Option 1EC ^a 85039B (Type-F, 75 Ω) Cal Kit, User 2-Port Calibration		
Description	Specification ^b (in dB)	
	300 kHz to 1.3 GHz	1.3 GHz to 3 GHz
Directivity	38	32
Source Match	36	30
Load Match	38	32
Reflection Tracking ^c	±0.019	±0.033
Transmission Tracking ^c	±0.045	±0.09

Transmission Uncertainty (Specification)^{b,d}

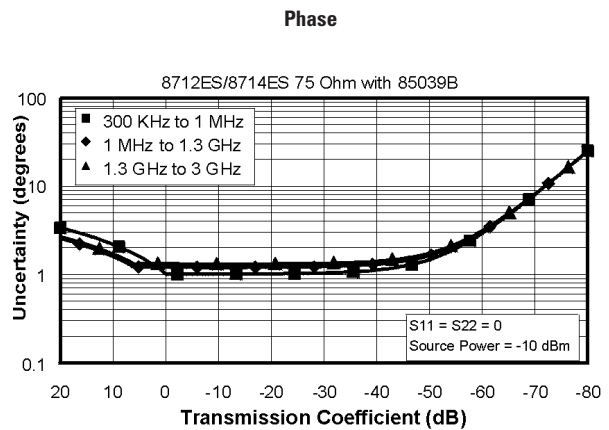
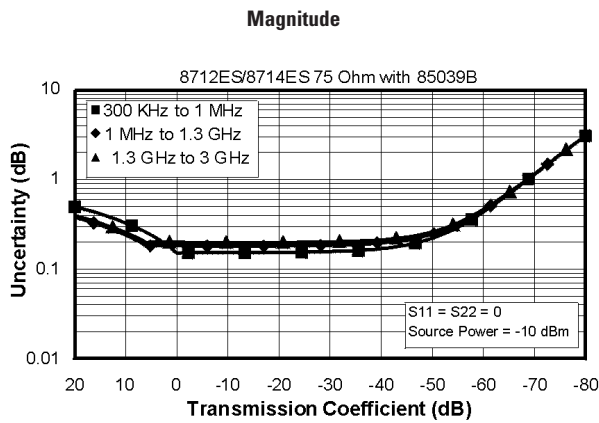

Reflection Uncertainty (Specification)^b

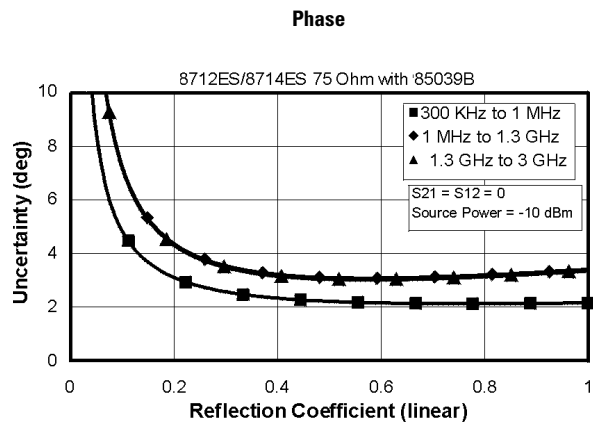
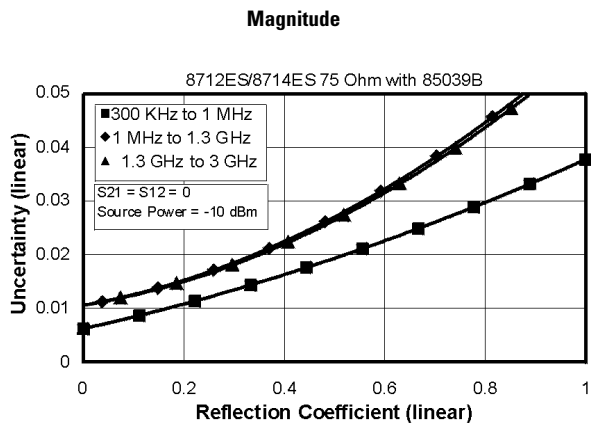

- Option 1EC provides 75 Ω system impedance.
- These specifications apply for measurements made using the “fine” (15 Hz) bandwidth, no averaging, and at an ambient temperature of 25° ±5° C, with less than 1° C deviation from the calibration temperature.
- Assumes the use of an 85039B cal kit, and a DUT with a center pin conforming to the 0.77 to 0.86 mm limits.
- For transmission measurements, the effect of crosstalk is disregarded and $S_{12}=S_{21}$ for $S_{21} < 1.0$, $S_{12}=1/S_{21}$ for $S_{21} > 1.0$

System Performance, T/R Calibration (Type-N, 50 Ω)

8712ES/8714ES 85032B/E (Type-N, 50 Ω) Cal Kit, T/R Calibration		
Description	Specification ^a (in dB)	
	300 kHz to 1.3 GHz	1.3 GHz to 3 GHz
Directivity	50	47
Source Match:		
Reflection (One-Port Cal)	42	36
Transmission (Enhanced Response Cal)	42	36
Transmission (Response Cal)	18	15
Load Match	18	15
Reflection Tracking	±0.02	±0.02
Transmission Tracking:		
Enhanced Response Cal	±0.040	±0.055
Response Cal	±0.17	±0.3

- a. These specifications apply for measurements made using the “fine” (15 Hz) bandwidth, no averaging, and at an ambient temperature of 25° ±5° C, with less than 1° C deviation from the calibration temperature.
- b. For transmission measurements, the effect of crosstalk is disregarded and $S_{12}=S_{21}$ for $S_{21} < 1.0$, $S_{12}=1/S_{21}$ for $S_{21} > 1.0$

Transmission Uncertainty: Enhanced Response Calibration (Specification)^{a,b}

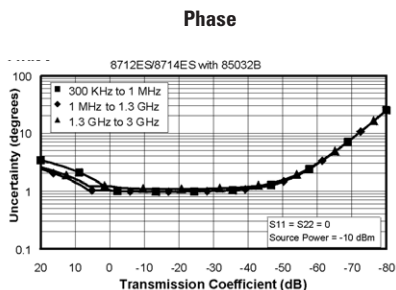
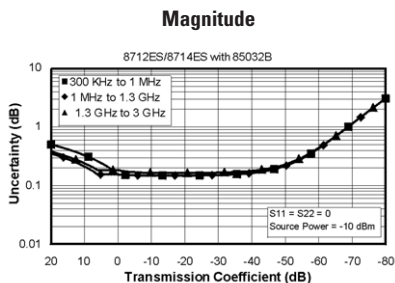

Transmission Uncertainty: Response Calibration (Specification)^{a,b}

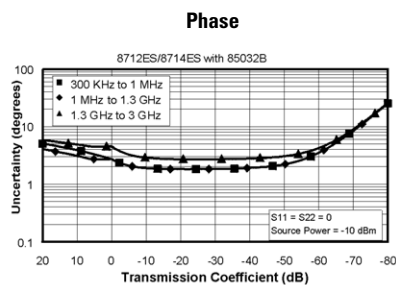
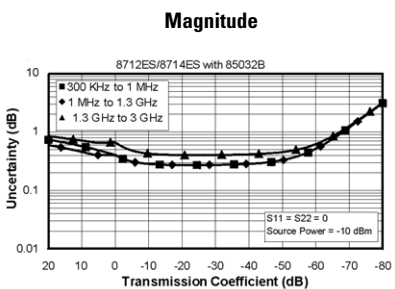

Reflection Uncertainty: One-Port Calibration (Specification)^a

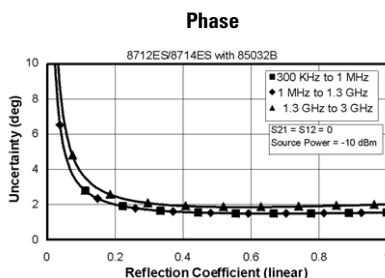
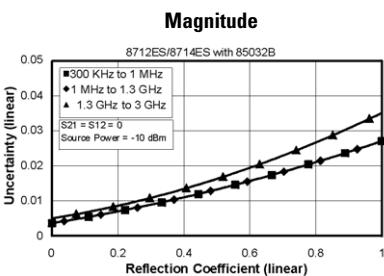

System Performance, T/R Calibration (Type-N, 50 Ω), *continued*

8712ET/8714ET 85032B/E (Type-N, 50 Ω) Cal Kit, T/R Calibration		
Description	Specification ^a (in dB)	
	300 kHz to 1.3 GHz	1.3 GHz to 3 GHz
Directivity	50	47
Source Match:		
Reflection (One-Port Cal)	42	36
Transmission (Enhanced Response Cal)	42	36
Transmission (Response Cal)	23	19
Load Match	18	15
Reflection Tracking	±0.02	±0.02
Transmission Tracking:		
Enhanced Response Cal	±0.039	±0.052
Response Cal	±0.105	±0.197

- These specifications apply for measurements made using the “fine” (15 Hz) bandwidth, no averaging, and at an ambient temperature of 25° ±5° C, with less than 1° C deviation from the calibration temperature.
- For transmission measurements, the effect of crosstalk is disregarded and $S_{12}=S_{21}$ for $S_{21} < 1.0$, $S_{12}=1/S_{21}$ for $S_{21} > 1.0$

Transmission Uncertainty: Enhanced Response Calibration (Specification)^{a,b}

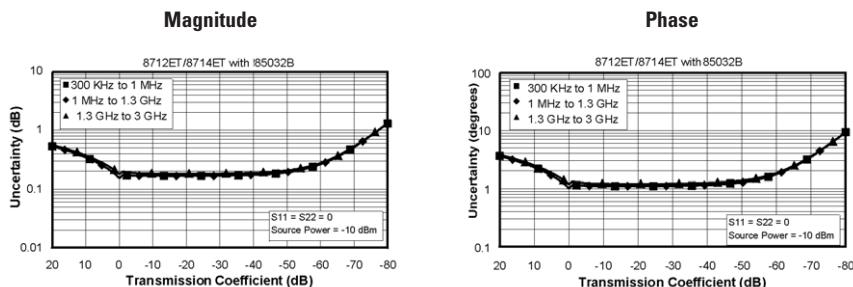

Transmission Uncertainty: Response Calibration (Specification)^{a,b}

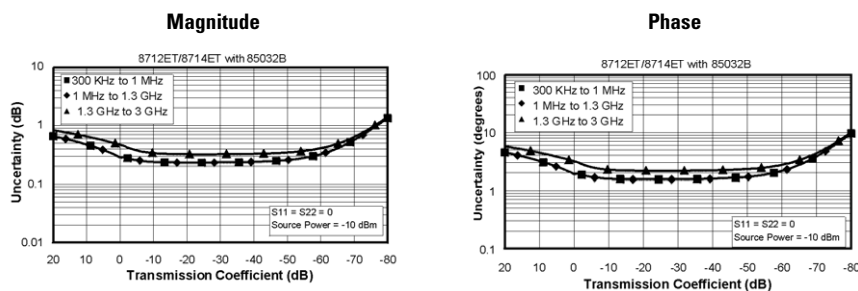

Reflection Uncertainty: One-Port Calibration (Specification)^a

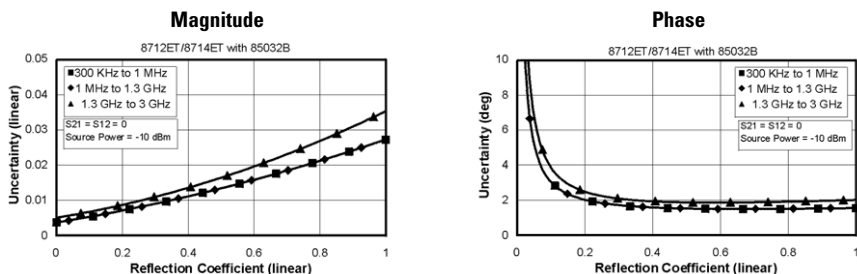

System Performance, T/R Calibration (Type-N, 50 Ω), *continued*

8712ET/8714ET with Attenuator Option 1E1 ^a 85032B/E (Type-N, 50 Ω) Cal Kit, T/R Calibration		
Description	Specification ^b (in dB)	
	300 kHz to 1.3 GHz	1.3 GHz to 3 GHz
Directivity	50	47
Source Match:		
Reflection (One-Port Cal)	42	36
Transmission (Enhanced Response Cal)	42	36
Transmission (Response Cal)	21	15
Load Match	18	15
Reflection Tracking	±0.02	±0.02
Transmission Tracking:		
Enhanced Response Cal	±0.039	±0.055
Response Cal	±0.13	±0.3

- a. Option 1E1 adds a 60 dB step attenuator.
- b. These specifications apply for measurements made using the “fine” (15 Hz) bandwidth, no averaging, and at an ambient temperature of 25° ±5° C, with less than 1° C deviation from the calibration temperature.
- c. For transmission measurements, the effect of crosstalk is disregarded and $S_{12}=S_{21}$ for $S_{21} < 1.0$, $S_{12}=1/S_{21}$ for $S_{21} > 1.0$.

Transmission Uncertainty: Enhanced Response Calibration (Specification)^{b,c}

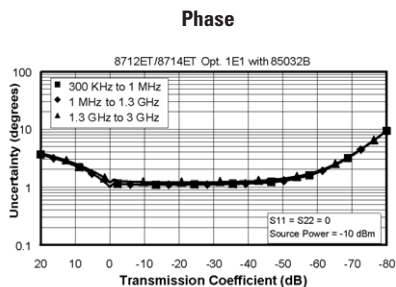
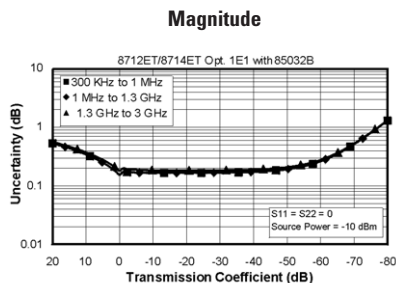

Transmission Uncertainty: Response Calibration (Specification)^{b,c}

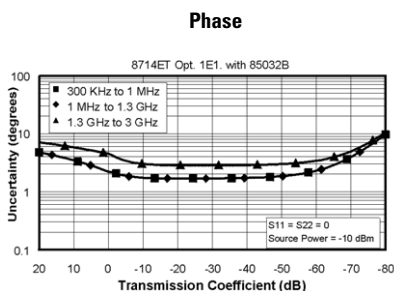
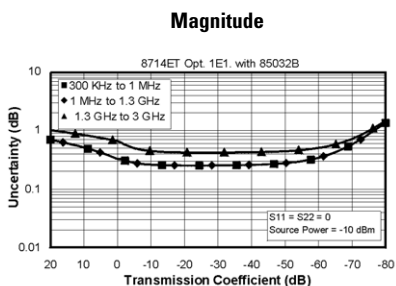

Reflection Uncertainty: One-Port Calibration (Specification)^b

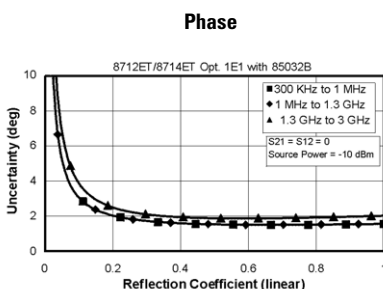
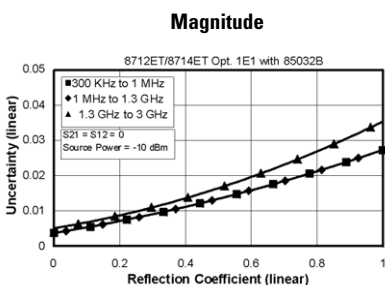

System Performance, T/R Calibration (Type-N, 75 Ω)

8712ES/8714ES with Option 1EC ^a 85036B/E (Type-N, 75 Ω) Cal Kit, T/R Calibration		
Description	Specification ^b (in dB)	
	300 kHz to 1.3 GHz	1.3 GHz to 3 GHz
Directivity	48	43
Source Match:		
Reflection (One-Port Cal)	41	35
Transmission (Enhanced Response Cal)	41	35
Transmission (Response Cal)	18	15
Load Match	18	15
Reflection Tracking	±0.021	±0.02
Transmission Tracking:		
Enhanced Response Cal	±0.042	±0.062
Response Cal	±0.17	±0.3

- a. Option 1EC provides 75 Ω system impedance.
- b. These specifications apply for measurements made using the “fine” (15 Hz) bandwidth, no averaging, and at an ambient temperature of 25° ±5° C, with less than 1° C deviation from the calibration temperature.
- c. For transmission measurements, the effect of crosstalk is disregarded and $S_{12}=S_{21}$ for $S_{21} < 1.0$, $S_{12}=1/S_{21}$ for $S_{21} > 1.0$.

Transmission Uncertainty: Enhanced Response Calibration (Specification)^{b,c}

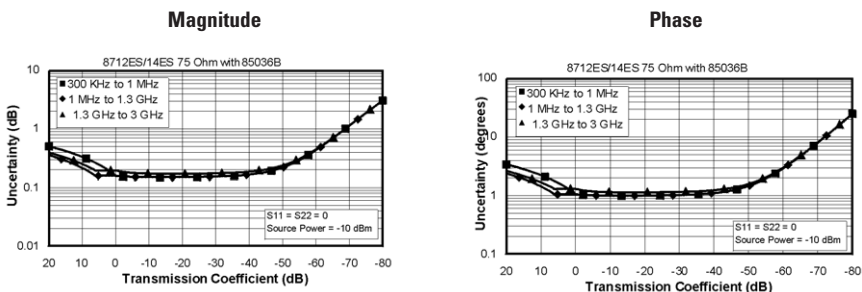

Transmission Uncertainty: Response Calibration (Specification)^{b,c}

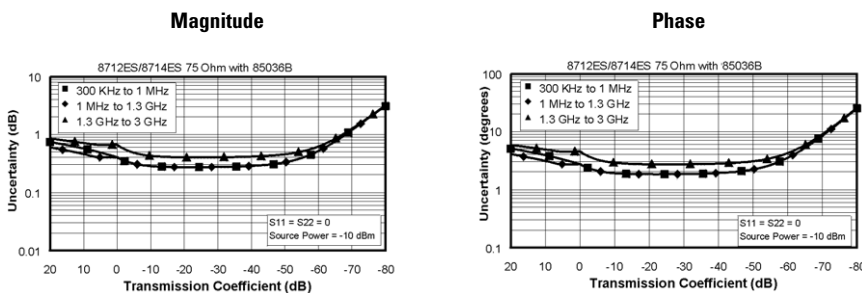

Reflection Uncertainty: One-Port Calibration (Specification)^b

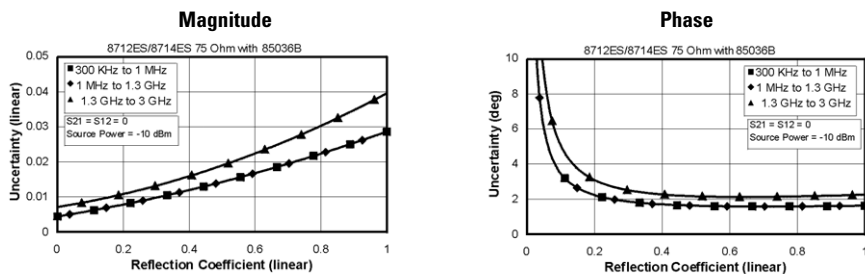

System Performance, T/R Calibration (Type-N, 75 Ω), continued

8712ET/8714ET with Option 1EC ^a (without Attenuator) 85036B/E (Type-N, 75 Ω) Cal Kit, T/R Calibration		
Description	Specification ^b (in dB)	
	300 kHz to 1.3 GHz	1.3 GHz to 3 GHz
Directivity	48	43
Source Match:		
Reflection (One-Port Cal)	41	35
Transmission (Enhanced Response Cal)	41	35
Transmission (Response Cal)	23	19
Load Match	18	15
Reflection Tracking	±0.021	±0.02
Transmission Tracking:		
Enhanced Response Cal	±0.04	±0.058
Response Cal	±0.11	±0.2

- a. Option 1EC provides 75 Ω system impedance.
- b. These specifications apply for measurements made using the “fine” (15 Hz) bandwidth, no averaging, and at an ambient temperature of 25° ±5° C, with less than 1° C deviation from the calibration temperature.
- c. For transmission measurements, the effect of crosstalk is disregarded and $S_{12}=S_{21}$ for $S_{21} < 1.0$, $S_{12}=1/S_{21}$ for $S_{21} > 1.0$.

Transmission Uncertainty: Enhanced Response Calibration (Specification)^{b,c}

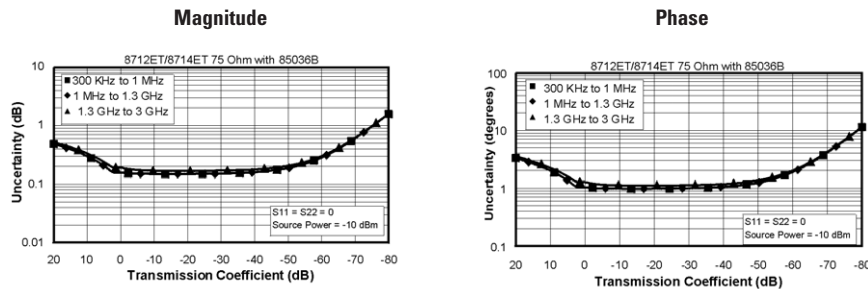

Transmission Uncertainty: Response Calibration (Specification)^{b,c}

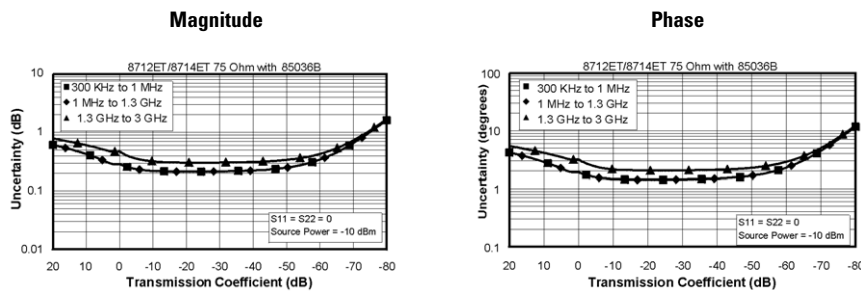

Reflection Uncertainty: One-Port Calibration (Specification)^b

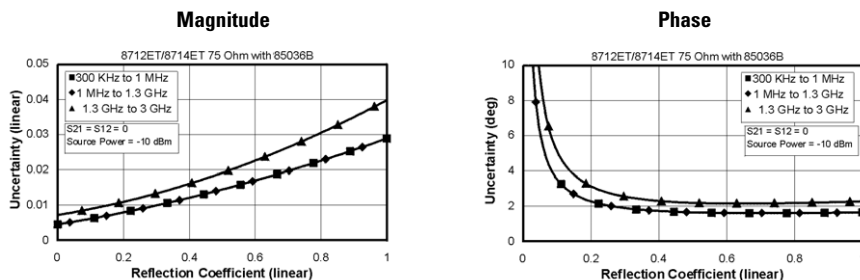

System Performance, T/R Calibration (Type-N, 75 Ω), continued

8712ET/8714ET with Options 1EC and 1E1 ^a 85036B/E (Type-N, 75 Ω) Cal Kit, T/R Calibration		
Description	Specification ^b (in dB)	
	300 kHz to 1.3 GHz	1.3 GHz to 3 GHz
Directivity	48	43
Source Match:		
Reflection (One-Port Cal)	41	35
Transmission (Enhanced Response Cal)	41	35
Transmission (Response Cal)	21	15
Load Match	18	15
Reflection Tracking	±0.021	±0.02
Transmission Tracking:		
Enhanced Response Cal	±0.04	±0.062
Response Cal	±0.125	±0.295

- a. Option 1EC provides 75 Ω system impedance. Option 1E1 adds a 60 dB step attenuator.
- b. These specifications apply for measurements made using the “fine” (15 Hz) bandwidth, no averaging, and at an ambient temperature of 25° ±5° C, with less than 1° C deviation from the calibration temperature.
- c. For transmission measurements, the effect of crosstalk is disregarded and $S_{12}=S_{21}$ for $S_{21} < 1.0$, $S_{12}=1/S_{21}$ for $S_{21} > 1.0$.

Transmission Uncertainty: Enhanced Response Calibration (Specification)^{b,c}

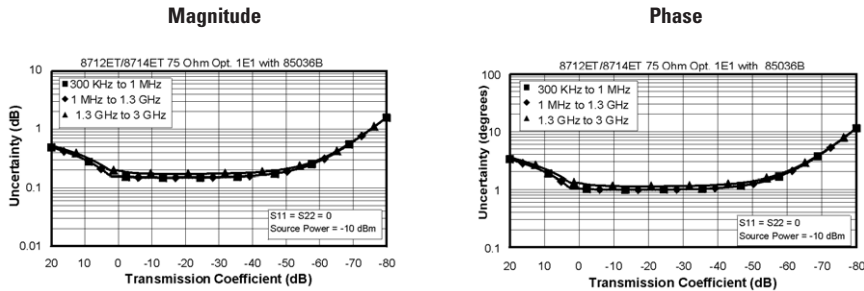

Transmission Uncertainty: Response Calibration (Specification)^{b,c}

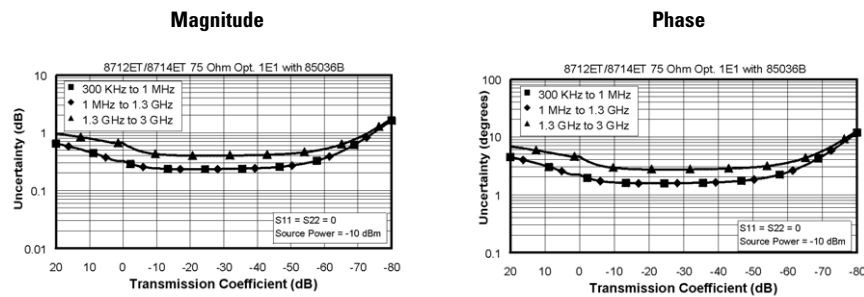

Reflection Uncertainty: One-Port Calibration (Specification)^b

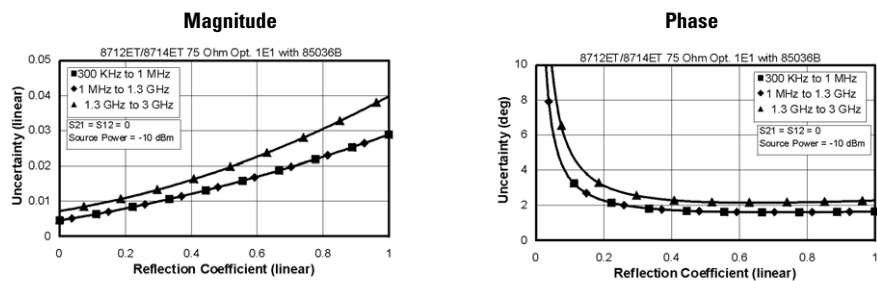

System Performance, Uncorrected

8712ET/ES and 8714ET/ES (Type-N, 50 Ω)						
Description	8712ES/8714ES		8712ET/8714ET (without Attenuator)		8712ET/8714ET with Attenuator Option 1E1 ^a	
	300 kHz to 1.3 GHz	1.3 GHz to 3 GHz	300 kHz to 1.3 GHz	1.3 GHz to 3 GHz	300 kHz to 1.3 GHz	1.3 GHz to 3 GHz
Specification^b (in dB)						
Directivity ^c	29	23	29	23	29	21
Source Match (Ratio) ^d	18	15	23	19	21	15
Load Match ^e	18	15	18	15	18	15
Crosstalk ^f	88	88	97	97	97	97
Typical^b (in dB)						
Directivity ^c	40	30	42	32	42	32
Source Match (Ratio) ^d	23	20	30	23	26	21
Load Match ^e	24	21	24	22	24	22
Reflection Tracking	±2.0	±2.0	±1.0	±1.0	±1.0	±1.5
Transmission Tracking	±2.0	±2.0	±1.5	±1.5	±1.5	±1.5
Crosstalk ^f	95	95	105	105	105	105

8712ET/ES and 8714ET/ES with Option 1EC (Type-N, 75 Ω)						
Description	8712ES/8714ES		8712ET/8714ET (without Attenuator)		8712ET/8714ET with Attenuator Option 1E1 ^a	
	300 kHz to 1.3 GHz	1.3 GHz to 3 GHz	300 kHz to 1.3 GHz	1.3 GHz to 3 GHz	300 kHz to 1.3 GHz	1.3 GHz to 3 GHz
Specification^b (in dB)						
Directivity ^c	27	19	27	18	27	19
Source Match (Ratio) ^d	18	15	23	19	21	15
Load Match ^e	18	15	18	15	18	15
Crosstalk ^f	88	88	97	97	97	97
Typical^b (in dB)						
Directivity ^c	40	30	40	30	40	30
Source Match (Ratio) ^d	23	20	28	23	24	20
Load Match ^e	24	22	24	22	24	22
Reflection Tracking	±1.5	±1.5	±1.0	±1.0	±1.0	±1.5
Transmission Tracking	±1.5	±1.5	±1.0	±1.0	±1.5	±1.5
Crosstalk ^f	95	95	105	105	105	105

- a. Option 1E1 adds a 60 dB step attenuator to the 8712ET/8714ET.
- b. These numbers apply for a measurement made using the “fine” bandwidth at an environmental temperature of 25° ±5° C.
- c. The uncorrected directivity of a network analyzer is calculated in linear terms by dividing the reflection measurement of an ideal load by the average of the reflection measurements of an ideal short and an ideal open.
- d. The uncorrected source match is the source match of the network analyzer when making a ratioed, uncalibrated measurement.
- e. The uncorrected load match is the match of the network analyzer port used on the load side of a measurement.
- f. Measured by setting output power to the maximum specified setting, connecting shorts to both ports, and measuring transmission. Typical and specified crosstalk values are 5 dB worse than those shown in the table below 1 MHz (for all models) and above 2.2 GHz (for 8714ET/ES models).

Test Port Output

8712ET/ES and 8714ET/ES Test Port Output		
Description	Specification (in dB)	Supplemental Information
Frequency		
Range: 8712ET/ES 8714ET/ES	300 kHz to 1.3 GHz 300 kHz to 3.0 GHz	
Resolution	1 Hz	
Stability		±5 ppm, 0° to 55° C, typical
CW Accuracy	±5 ppm, 25° ±5° C	<1 Hz with 10% change in line voltage, typical
Signal Purity		
Harmonics: 8712ET/ES 8714ET/ES	<-20 dBc at <1 MHz <-30 dBc at >1 MHz <-30 dBc	
Nonharmonic Spurious: 8712ET/ES, <50 kHz from carrier 8712ET/ES, >50 kHz from carrier 8714ET/ES, <50 kHz from carrier 8714ET/ES, >50 kHz from carrier		<-25 dBc, characteristic <-20 dBc at <1 MHz, char. <-30 dBc at >1 MHz, char. <-25 dBc, characteristic <-30 dBc, characteristic
Phase Noise (at 10 kHz offset): 8712ET/ES 8714ET/ES		<-67 dBc/Hz, characteristic <-67 dBc/Hz, characteristic
Residual AM (in 100 kHz bandwidth)		<-50 dBc, nominal
Residual FM (30 Hz to 15 kHz)		<1.5 kHz peak, nominal
Output Power		
Level Accuracy: 8712ET: 50 Ω: With Attenuator Option 1E1 ^a Without Attenuator 75 Ω: With Attenuator Option 1E1 ^a Without Attenuator 8712ES: 50 Ω 75 Ω 8714ET: 50 Ω: With Attenuator Option 1E1 ^a Without Attenuator 75 Ω: With Attenuator Option 1E1 ^a Without Attenuator 8714ES: 50 Ω 75 Ω	±2.0 dB ±1.0 dB ±3.0 dB ±1.5 dB ±2.0 dB ±3.0 dB ±2.0 dB ±1.0 dB ±3.0 dB at <2 GHz ±1.5 dB at <2 GHz ±2.0 dB ±3.0 dB at <2 GHz	±3.0 dB at >2 GHz, char. ±1.5 dB at >2 GHz, char. ±3.0 dB at >2 GHz, char.
Minimum Power: 8712ET: 50 Ω: With Attenuator Option 1E1 ^a Without Attenuator 75 Ω: With Attenuator Option 1E1 ^a Without Attenuator 8712ES: 50 Ω 75 Ω 8714ET: 50 Ω: With Attenuator Option 1E1 ^a Without Attenuator 75 Ω: With Attenuator Option 1E1 ^a Without Attenuator 8714ES: 50 Ω 75 Ω		-60 dBm, nominal -0 dBm, nominal -60 dBm, nominal -3 dBm, nominal -60 dBm, nominal -60 dBm, nominal -60 dBm, nominal -5 dBm, nominal -60 dBm, nominal -8 dBm, nominal -60 dBm, nominal -60 dBm, nominal

a. Option 1E1 adds a 60 dB step attenuator.

Test Port Output, *continued*

8712ET/ES and 8714ET/ES Test Port Output			
Description	Specification (in dB)		Supplemental Information
	<1 GHz	>1 GHz	
Output Power (continued)			
Maximum Power:			
8712ET:			
50 Ω: With Attenuator Option 1E1 ^a	15 dBm	12 dBm	
Without Attenuator	16 dBm	13 dBm	
75 Ω: With Attenuator Option 1E1 ^a	12 dBm	9 dBm	
Without Attenuator	13 dBm	10 dBm	
8712ES:			
50 Ω	13 dBm	10 dBm	
75 Ω	10 dBm	7 dBm	
8714ET:			
50 Ω: With Attenuator Option 1E1 ^a	10 dBm	9 dBm	
Without Attenuator	11 dBm	10 dBm	
75 Ω: With Attenuator Option 1E1 ^a	7 dBm	6 dBm at <2 GHz	6 dBm at >2 GHz, characteristic
Without Attenuator	8 dBm	7 dBm at <2 GHz	7 dBm at >2 GHz, characteristic
8714ES:			
50 Ω	9 dBm	7 dBm	
75 Ω	6 dBm	4 dBm at <2 GHz	4 dBm at >2 GHz, characteristic
Power Resolution	0.01 dBm		
Attenuator Switch Points:			(All values nominal)
8712ET:			
50 Ω:			-1, -11, -21, -31, -41, -51 dBm
75 Ω:			-4, -14, -24, -34, -44, -54 dBm
8712ES:			
50 Ω			-3, -13, -23, -33, -43, -53 dBm
75 Ω			-6, -16, -26, -36, -46, -56 dBm
8714ET:			
50 Ω:			-6, -16, -26, -36, -46, -56 dBm
75 Ω:			-9, -19, -29, -39, -49, -59 dBm
8714ES:			
50 Ω			-8, -18, -28, -38, -48, -58 dBm
75 Ω			-11, -21, -31, -41, -51 dBm

8712ET/ES and 8714ET/ES Test Port Output							
Description	Nominal (in dBm)						
	Attenuator						
Output Power (continued)	0 dB	10 dB	20 dB	30 dB	40 dB	50 dB	60 dB
Power Sweep Ranges:							
8712ET:							
50 Ω: With Attenuator Option 1E1 ^a	-1 to P _{max} ^b	-11 to 2	-21 to -8	-31 to -18	-41 to -28	-51 to -38	-60 to -48
Without Attenuator	0 to P _{max} ^b						
75 Ω: With Attenuator Option 1E1 ^a	-4 to P _{max} ^b	-14 to -1	-24 to -11	-34 to -21	-44 to -31	-54 to -41	-60 to -51
Without Attenuator	-3 to P _{max} ^b						
8712ES:							
50 Ω	-3 to P _{max} ^b	-13 to 0	-23 to -10	-33 to -20	-43 to -30	-53 to -40	-60 to -50
75 Ω	-6 to P _{max} ^b	-16 to -3	-26 to -13	-36 to -23	-46 to -33	-56 to -43	-60 to -53
8714ET:							
50 Ω: With Attenuator Option 1E1 ^a	-6 to P _{max} ^b	-16 to -1	-26 to -11	-36 to -21	-46 to -31	-56 to -41	-60 to -51
Without Attenuator	-5 to P _{max} ^b						
75 Ω: With Attenuator Option 1E1 ^a	-9 to P _{max} ^b	-19 to -4	-29 to -14	-39 to -24	-49 to -34	-59 to -44	-60 to -54
Without Attenuator	-8 to P _{max} ^b						
8714ES:							
50 Ω	-8 to P _{max} ^b	-18 to -3	-28 to -13	-38 to -23	-48 to -33	-58 to -43	-60 to -53
75 Ω	-11 to P _{max} ^b	-21 to -6	-31 to -16	-41 to -26	-51 to -36	-60 to -46	-60 to -56

a. Option 1E1 adds a 60 dB step attenuator .

b. P_{max} = maximum power

Test Port Input

8712ET/ES and 8714ET/ES Test Port Input		
Description	Specification	Supplemental Information
Frequency Range		
8712ET/ES Narrowband Broadband	300 kHz to 1.3 GHz 10 MHz to 1.3 GHz	
8714ET/ES Narrowband Broadband	300 kHz to 3.0 GHz 10 MHz to 3.0 GHz	
Maximum Input Level		
8712ET/8714ET Narrowband Broadband	+10 dBm at 0.5 dB compression	+16 dBm at 0.5 dB compression, characteristic
8712ES/8714ES Narrowband Broadband	+10 dBm at 0.5 dB compression	+16 dBm at 0.5 dB compression, characteristic
Damage Level		
8712ET/8714ET	+20 dBm; ± 30 VDC	
8712ES/8714ES	+26 dBm; ± 30 VDC	
Broadband Flatness		
8712ET/ES and 8714ET/ES		± 1 dB, characteristic

Test Port Input, *continued*

8712ET/ES and 8714ET/ES Test Port Input				
Description	Specification (in dBm)	Typical (in dBm)		
	System Bandwidths:			
	Fine (15 Hz)	Fine (15 Hz)	Med Wide (4000 Hz)	Wide (6500 Hz)
Noise Floor^a				
8712ET/8714ET:				
50 Ω:				
Narrowband	-105	-111	-86	-48
Broadband (Internal)	-50	-55	-48	-32
75 Ω:				
Narrowband	-104	-109	-84	-46
Broadband (Internal)	-47	-52	-45	-30
8712ES/8714ES:				
50 Ω:				
Narrowband	-96	-105	-80	-47
Broadband (Internal)	-38	-43	-36	-23
75 Ω:				
Narrowband	-95	-104	-80	-47
Broadband (Internal)	-35	-40	-33	-20
System Dynamic Range^b		(in dB)		
8712ET:				
50 Ω:				
With Attenuator Option 1E1 ^c :				
Narrowband	115	121	96	58
Broadband (Internal)	60	67	60	44
Without Attenuator				
Narrowband	115	121	96	58
Broadband (Internal)	62	68	61	45
75 Ω:				
With Attenuator Option 1E1 ^{b,c} :				
Narrowband	110	118	93	55
Broadband (Internal)	53	61	54	39
Without Attenuator				
Narrowband	113	119	94	56
Broadband (Internal)	56	62	55	40
8714ET:				
50 Ω:				
With Attenuator Option 1E1 ^c :				
Narrowband	112	120	95	57
Broadband (Internal)	57	64	57	41
Without Attenuator				
Narrowband	114	121	96	58
Broadband (Internal)	59	65	58	42
75 Ω:				
With Attenuator Option 1E1 ^{b,c} :				
Narrowband	107	115	90	52
Broadband (Internal)	50	58	51	36
Without Attenuator				
Narrowband	110	116	91	53
Broadband (Internal)	53	59	52	37

- Noise floor is defined as the RMS value of the trace (in linear format) for a transmission measurement in CW frequency mode, with RF connectors terminated in loads, output power set to 0 dBm, and no averaging. The noise floor specifications and typicals for narrowband detection measurements assume that an isolation calibration has been performed using an average factor of 16. For the 8712ES/8714ES, external broadband detectors will provide a much lower noise floor than the internal broadband detectors.
- The System Dynamic Range is calculated as the difference between the receiver noise floor and the minimum of either the source maximum output (maximum power setting minus output power level accuracy) or the receiver maximum input. System Dynamic Range applies to transmission measurements only, since reflection measurements are limited by directivity. The System Dynamic Range for 8714ET/ES 75 Ω analyzers is not a specification for frequencies >2 GHz; it is a characteristic. For the 8712ES/8714ES, external broadband detectors will provide much more dynamic range than the internal broadband detectors.
- Option 1E1 adds a 60 dB step attenuator.

Test Port Input, *continued*

8712ET/ES and 8714ET/ES Test Port Input				
Description	Specification (in dB)	Typical (in dB)		
	System Bandwidths:			
	Fine (15 Hz)	Fine (15 Hz)	Med Wide (4000 Hz)	Wide (6500 Hz)
System Dynamic Range^a (continued)				
8712ES: 50 Ω: Narrowband	104	115	90	57
Broadband (Internal)	46	53	46	33
75 Ω: Narrowband	99	111	87	54
Broadband (Internal)	39	47	40	27
8714ES: 50 Ω: Narrowband	101	112	87	54
Broadband (Internal)	43	50	43	30
75 Ω: Narrowband	96	108	84	51
Broadband (Internal)	36	44	37	24
Receiver Dynamic Range^b				
8712ET/8714ET: 50 Ω: Narrowband	115	121	96	58
Broadband (Internal)	66	71	64	48
75 Ω: Narrowband	114	119	94	56
Broadband (Internal)	63	68	61	46
8712ES/8714ES: 50 Ω: Narrowband	106	115	90	57
Broadband (Internal)	54	59	52	39
75 Ω: Narrowband	105	114	90	57
Broadband (Internal)	51	56	49	36
	Narrow (250 Hz)	Narrow (250 Hz)	Med Wide (4000 Hz)	Wide (6500 Hz)
Trace Noise^c				
8712ET/8714ET: Narrowband: Magnitude	0.01 dB rms	0.03 dB-pp	0.12 dB-pp	0.28 dB-pp
Phase		0.2 deg-pp	2.5 deg-pp	3.4 deg-pp
Broadband: Magnitude	0.01 dB rms	0.01 dB-pp	0.02 dB-pp	0.15 dB-pp
8712ES/8714ES: Narrowband: Magnitude	0.01 dB rms	0.02 dB-pp	0.06 dB-pp	0.23 dB-pp
Phase		0.2 deg-pp	0.8 deg-pp	1.8 deg-pp
Broadband: Magnitude	0.01 dB rms	0.01 dB-pp	0.03 dB-pp	0.16 dB-pp

- The System Dynamic Range is calculated as the difference between the receiver noise floor and the minimum of either the source maximum output (maximum power setting minus output power level accuracy) or the receiver maximum input. System Dynamic Range applies to transmission measurements only, since reflection measurements are limited by directivity. The System Dynamic Range for 8714ET/ES 75 Ω analyzers is not a specification for frequencies >2 GHz; it is a characteristic. For the 8712ES/8714ES, external broadband detectors will provide much more dynamic range than the internal broadband detectors.
- The Receiver Dynamic Range is calculated as the difference between the receiver noise floor and the receiver maximum input. Receiver Dynamic Range applies to transmission measurements only, since reflection measurements are limited by directivity. The Receiver Dynamic Range for 8714ET/ES 75 Ω analyzers is not a specification for frequencies >2 GHz; it is a characteristic. For the 8712ES/8714ES, external broadband detectors will provide much more dynamic range than the internal broadband detectors.
- Trace noise is defined for a transmission measurement in CW mode, using a “through” cable having 0 dB loss, with the source set to 0 dBm, and the analyzer’s averaging function turned off.

Test Port Input, *continued*

Dynamic Accuracy (Specification)^{a,b}

8712ET/8714ET:

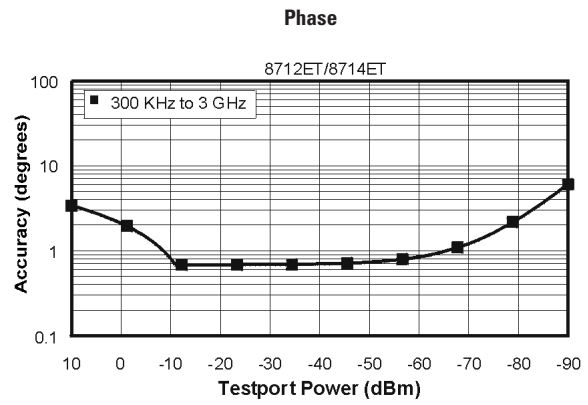
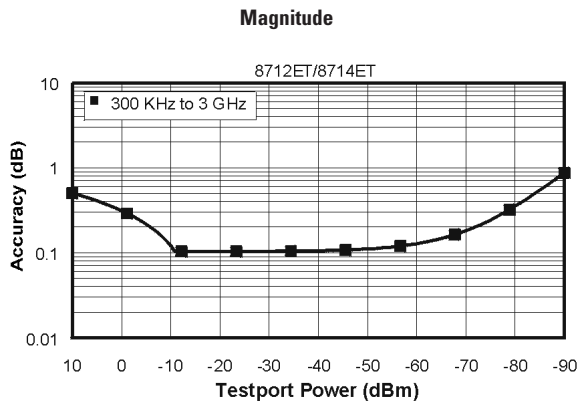

Dynamic Accuracy (Specification)^{a,b}

8712ES/8714ES:

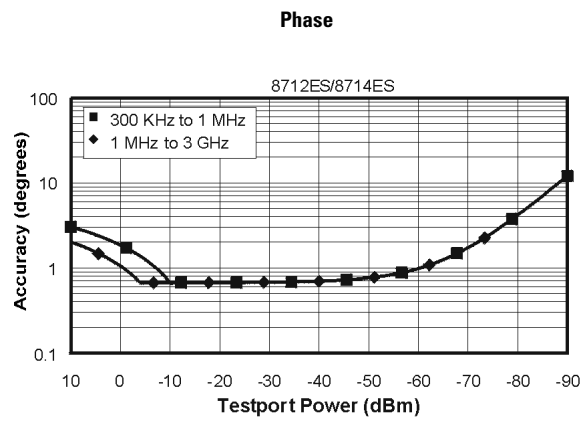
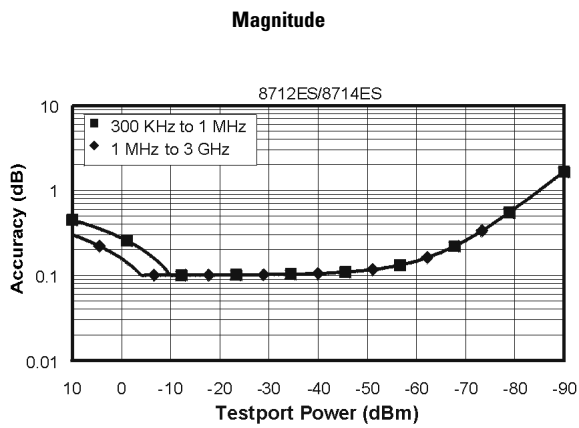

- a. Narrowband detection mode
- b. The reference power for dynamic accuracy is -20 dBm.

Test Port Input, continued

Power Accuracy (Characteristic)^a

8712ET/8714ET:

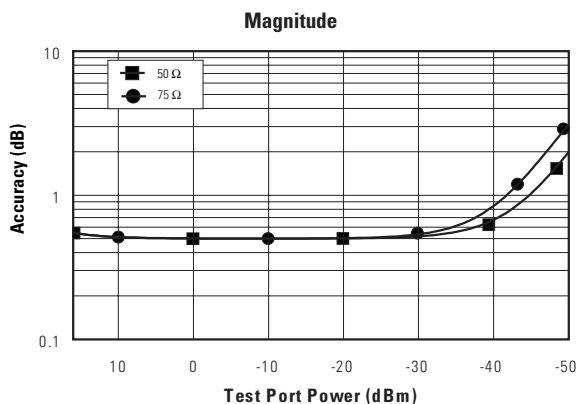

8712ES/8714ES:

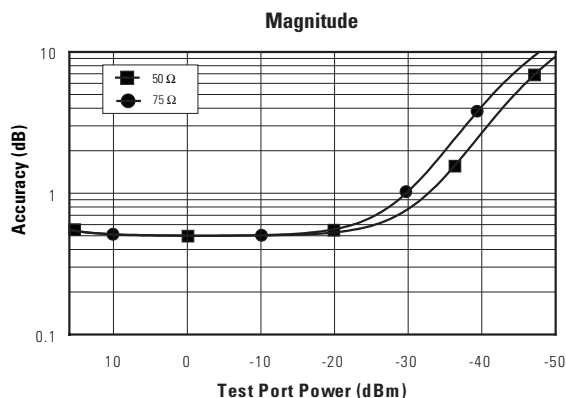

Group Delay Accuracy (Specification)^b

8712ET/ES and 8714ET/ES

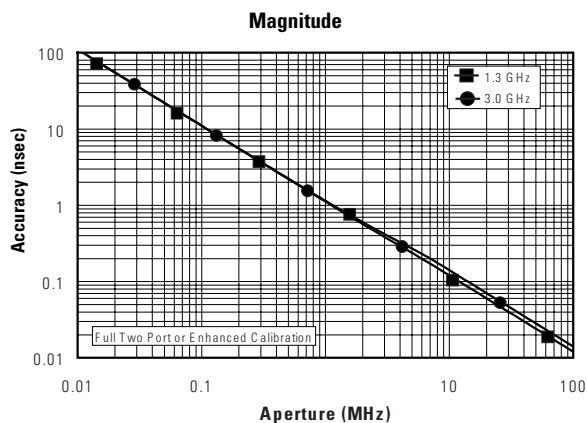

a. At 30 MHz, broadband mode, internal detectors

b. Valid for 85032B/E (type-N, 50 Ω) and 85036B/E (type-N, 75 Ω) cal kits using either a two-port or enhanced response calibration.

General Information

8712ET/ES and 8714ET/ES General Information		
Description	Specification	Supplemental Information
Display Range		
Magnitude Phase Polar	200 dB (at 20 dB/div), max 1800° (at 180°/div), max 1 MUnit, max	
Display Resolution		
Magnitude Phase Polar	0.01 dB/div, min 0.1°/div, min 10 μUnit full scale, min	
Reference Level Range		
Magnitude Phase	500 dB, max 360°, max	
Reference Level Resolution		
Magnitude Phase	0.01 dB, min 0.01°, min	
Marker Resolution		
Magnitude Phase Polar	0.001 dB, min 0.01°, min 0.01 mUnit, min; 0.01°, min	
Group Delay Aperture		
Magnitude Phase	20% of frequency span Frequency span ÷ (num. of points -1)	
Group Delay Range		
	1 ÷ (2 x minimum aperture)	The maximum delay is limited to measuring no more than 180° of phase change within the minimum aperture.
System Bandwidths		
Wide (6500 Hz) Medium Wide (4000 Hz) Medium (3700 Hz) Medium Narrow (1200 Hz) Narrow (250 Hz) Fine (15 Hz)		6500 Hz, nominal 4000 Hz, nominal 3700 Hz, nominal 1200 Hz, nominal 250 Hz, nominal 15 Hz, nominal

General Information, *continued*

8712ET/ES and 8714ET/ES General Information		
Description	Specification	Supplemental Information
Rear Panel		
Auxiliary Input: Connector Impedance Range Accuracy Damage Level	± 10 V $\pm 3\%$ of reading + 20 mV >+15 V; <-15 V	Female BNC 10 k Ω , nominal
External Trigger In/Out: Damage Level	 <-0.2 V; >+5.2 V	Female BNC; open-collector with 681 Ω nom. pullup resistor to +5 V, nominal. Normally high, pulsed low after each data point is measured.
Limit Test Output: Damage Level	 <-0.2 V; >+5.2 V	Female BNC; open-collector with 681 Ω nom. pullup resistor to +5 V, nominal. Normally high, pulled low when limit test fails.
User TTL Input/Output: Damage Level	 <-0.2 V; >+5.2 V	Female BNC; open-collector with 681 Ω nom. pullup resistor to +5 V, nominal. Programmable as: high-sweep output; trigger input; general I/O for IBASIC.
External Reference In: Input Frequency Input Power Input Impedance		10 MHz, nominal -5 dBm to +12 dBm, nominal 50 Ω , nominal
VGA Video Output GPIB		15-pin mini D-Sub; female. Firmware supports normal and inverse video color formats. Type-57, 24-pin; Microribbon female
X and Y External Detector Inputs		12-pin circular; female
Parallel Port		25-pin D-Sub (DB-25); female
LAN		8-pin RJ45; female
RS232		9-pin D-Sub (DB-9); male
Mini-DIN Keyboard/Barcode Reader		6-pin mini DIN (PS/2); female
Line Power ^a : Frequency Voltage at 115 V setting Voltage at 220 V setting Power	47 Hz to 63 Hz 90 V to 132 V 198 V to 264 V 300 VA, max	115 V, nominal. 230 V, nominal. 230 W, nominal
Front Panel		
RF Connectors		Type-N female; 50 Ω , nominal (With Option 1EC only: type-N female; 75 Ω , nominal)
Probe Power: Positive Supply Negative Supply	200 mA, max 250 mA, max	3-pin connector; male +15 V, nominal; 0.75 A fuse, nominal -12.6 V, nominal; 0.75 A fuse, nominal
General Environmental		
RFI/EMI Susceptibility		Defined by CISPR Pub. 11 and FCC Class B standards.
ESD		Minimize using static-safe work procedures and an antistatic bench mat (part number 9300-0797).
Dust		Minimize for optimum reliability.
Operating Environment		
Temperature	0° C to +55° C	
Humidity	5% to 95% at +40° C	
Altitude	0 to 4.5 km (15,000 ft.)	
Storage Conditions		
Temperature	-40° C to +70° C	
Humidity	0% to 95% RH at +65° C (noncondensing)	
Altitude	0 to 15.24 km (50,000 ft.)	
Cabinet Dimensions		
Height x Width x Depth		179 x 425 x 514 mm (7.0 x 16.75 x 20.25 in), nominal Cabinet dimensions exclude front and rear protrusions.
Weight		
Shipping		40 kg (88 lb.), nominal
Net		24.4 kg (54 lb.), nominal

a. A third-wire ground is required.

General Information, *continued*

Measurement throughput summary

8712ET/ES and 8714ET/ES General Information								
Measurement Speed Conditions ^a					Typical			
Cal Type	Number of Channels	Measurement Bandwidth (Hz)	Number of Points	Frequency Span ^b	Cycle Time ^c	Recall State & Cal ^d	Data Transfer ^e	Measurement Cycle ^f
1-port	1	6500	201	100 MHz	72 ms			
1-port	1	6500	201	2 GHz	160 ms			
1-port	1	4000	11	100 MHz	37 ms			
1-port	1	4000	21	100 MHz	42 ms			
1-port	1	4000	51	100 MHz	55 ms	470 ms	26 ms	630 ms
1-port	1	4000	101	100 MHz	76 ms			
1-port	1	4000	201	100 MHz	119 ms	580 ms	38 ms	760 ms
1-port	1	4000	201	2 GHz	180 ms			
1-port	1	4000	401	100 MHz	207 ms			
1-port	1	4000	801	100 MHz	380 ms			
1-port	1	4000	1601	100 MHz	730 ms	1600 ms	160 ms	2560 ms
1-port	1	3700	201	100 MHz	157 ms			
1-port	1	3700	201	2 GHz	218 ms			
1-port	1	1200	201	100 MHz	332 ms			
1-port	1	1200	201	2 GHz	394 ms			
1-port	1	250	201	100 MHz	1520 ms			
1-port	1	250	201	2 GHz	1604 ms			
1-port	1	15	201	100 MHz	12320 ms			
1-port	1	15	201	2 GHz	12380 ms			
1-port	2	4000	51	100 MHz	56 ms	630 ms	58 ms	840 ms
1-port	2	4000	201	100 MHz	120 ms	840 ms	80 ms	1100 ms
1-port	2	4000	1601	100 MHz	736 ms	2600 ms	310 ms	3700 ms
2-port	1	4000	51	100 MHz	109 ms	500 ms	26 ms	720 ms
2-port	1	4000	201	100 MHz	240 ms	670 ms	38 ms	1040 ms
2-port	1	4000	1601	100 MHz	1460 ms	2200 ms	160 ms	3950 ms
2-port	2	4000	51	100 MHz	109 ms	710 ms	60 ms	1130 ms
2-port	2	4000	201	100 MHz	240 ms	940 ms	78 ms	1470 ms
2-port	2	4000	1601	100 MHz	1460 ms	3500 ms	310 ms	5480 ms

- a. Measurements are always made with error correction enabled.
- b. Center frequency is set to 1 GHz.
- c. "Cycle Time" is the time required for the analyzer to finish one complete sweep cycle including the forward sweep (and reverse sweep when using two-port calibration), retrace, bandcrossings, and calculation time when in the "Continuous Sweep" mode.
- d. This is the time to recall both the system state and calibration data.
- e. "Data Transfer" is performed using an HP S700 workstation. The GPIB port is used to transfer "corrected" 64-bit, floating point numbers (real and imaginary).
- f. A "Measurement Cycle" is defined as the time required for an HP S700 workstation to control the analyzer to: (1) recall the state and calibration (analyzer is now in "sweep hold" mode), (2) sweep (using the ":INIT1; *OPC?" command), and (3) transfer data. This may be less than the sum of the other columns since a complete "Cycle Time" doesn't need to be done for the controller to transfer data.

General Information, *continued*

Data transfer times

The tables below show the various data transfer speeds that can be expected using different data formats. Please note the following:

- ASCII data transfers are considerably slower than the other types.
- IBASIC CSUBs (compiled routines) can access trace data faster than an external computer.
- If only a few trace points need to be queried, using markers can be faster.

Trace Transfer Time via GPIB (using an HP S700 UX Workstation)

		Number of Trace Points				
Data	Format	11	51	201	401	1601
Formatted	ASCII	14 ms	43 ms	160 ms	305 ms	1200 ms
Formatted	Real, 32-bit floating point	10 ms	11 ms	20 ms	24 ms	62 ms
Formatted	Real, 64-bit floating point	10 ms	12 ms	20 ms	34 ms	105 ms
Corrected	ASCII	20 ms	79 ms	294 ms	574 ms	2239 ms
Corrected	Complex, 64-bit floating point	10 ms	16 ms	31 ms	50 ms	172 ms
Corrected	Complex, 16-bit integer	10 ms	15 ms	28 ms	32 ms	90 ms

Accessing Trace Data with IBASIC Using CSUBs

		Number of Trace Points				
Data	Format	11	51	201	401	1601
Formatted	ASCII	7 ms	7 ms	7 ms	8 ms	18 ms
Formatted	Real, 32-bit floating point	7 ms	7 ms	9 ms	11 ms	31 ms

Transferring a Single Marker Value via GPIB

CALC:MARK1:Y? <10 ms

Block diagrams

Simplified Block Diagram for the 8712ET and 8714ET

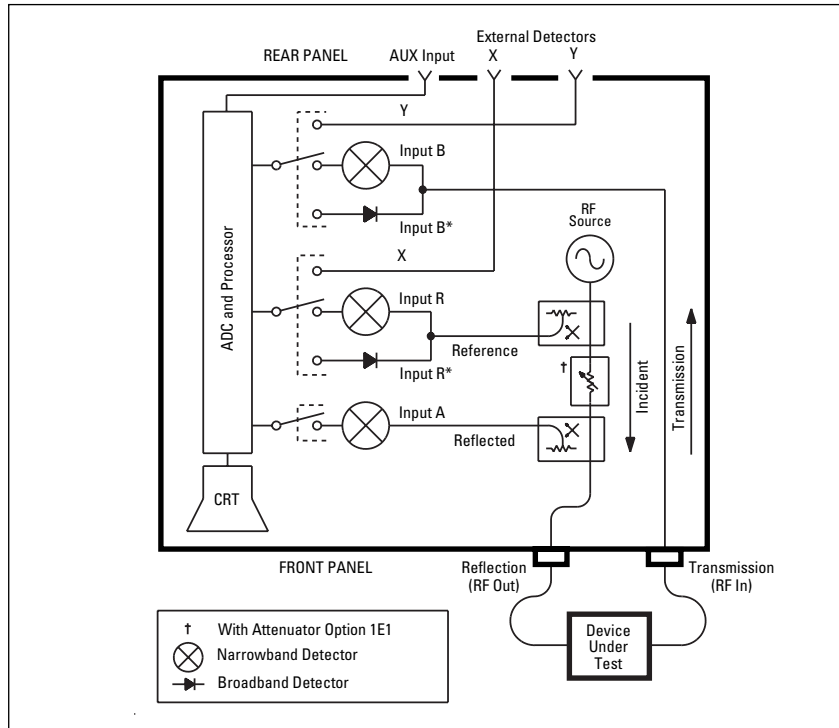

Simplified Block Diagram for the 8712ES and 8714ES

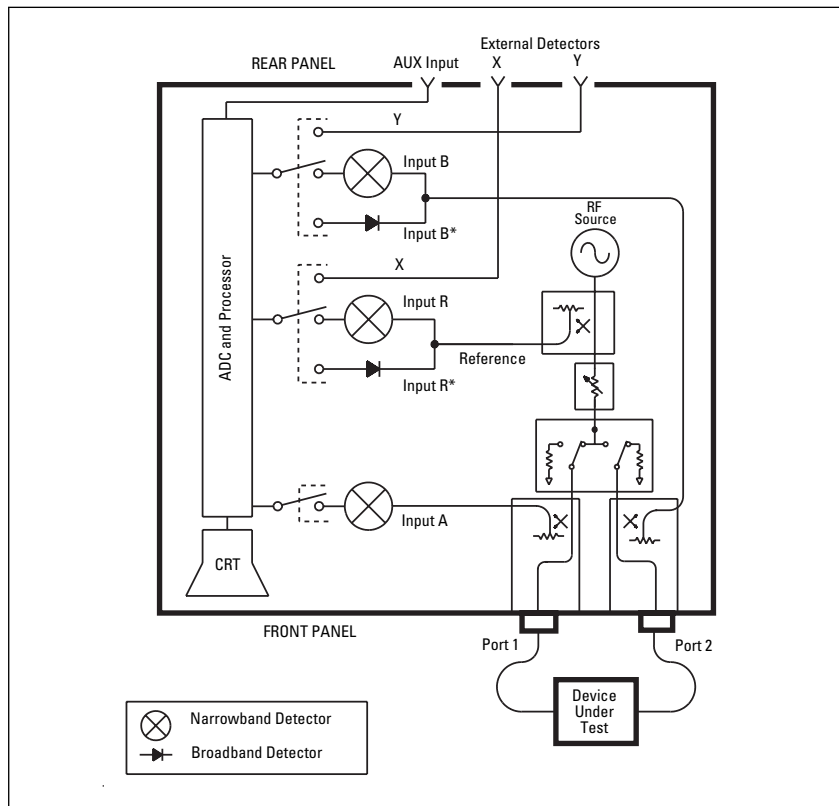

Product features

Measurement

Number of display measurements

Two measurement displays are available, with independent control of display parameters including format type, scale per division, reference level, reference position, and averaging. The displays can share network analyzer sweep parameters, or, by using alternate sweep, each measurement can have independent sweep parameters including frequency settings, IF bandwidth, power level, and number of trace points. The instrument can display a single measurement, or dual measurements on a split (two graticules) or overlaid (one graticule) screen.

Measurement choices

- **Narrowband**
ET models: reflection (A/R), transmission (B/R), A, B, R
ES models: S_{11} (A/R), S_{22} (B/R), S_{21} (B/R), S_{12} (A/R), A, B, R
- **Broadband**
X, Y, Y/X, X/Y, Y/R*, power (B*, R*), conversion loss (B*/R*).

Note: X and Y denote external broadband-detector inputs;
* denotes internal broadband detectors.

Formats

Log or linear magnitude, SWR, phase, group delay, real and imaginary, Smith chart, polar, and impedance magnitude.

Trace functions

Current data, memory data, memory with current data, division of data by memory.

Display annotations

Start/stop, center/span, or CW frequency, scale per division, reference level, marker data, softkey labels, warning and caution messages, screen titles, time and date, and pass/fail indication.

Limits

Measurement data can be compared to any combination of line or point limits for pass/fail testing. User-defined limits can also be applied to an amplitude- or frequency-reference marker. A limit-test TTL output is available on the rear panel for external control or indication. Limits are only available with rectilinear formats.

Data markers

Each measurement channel has eight markers. Markers are coupled between channels. Any one of eight markers can be the reference marker for delta-marker operation. Annotation for up to four markers can be displayed at one time.

Marker functions

Markers can be used in absolute or delta modes. Other marker functions include marker to center frequency, marker to reference level, marker to electrical delay, searches, tracking, and statistics. Marker searches include marker to maximum, marker to minimum, marker to target value, bandwidth, notch, multi-peak and multi-notch. The marker-tracking function enables continuous update of marker search values on each sweep. Marker statistics enable measurement of the mean, peak-to-peak and standard deviation of the data between two markers. For rapid tuning and testing of cable-TV broadband amplifiers, slope and flatness functions are also available.

Storage

Internal memory

1.5 Mbytes (ET models) or 1 Mbyte (ES models) of nonvolatile storage is available to store instrument states, measurement data, screen images, and IBASIC programs. Instrument states can include all control settings, limit lines, memory data, calibration coefficients, and custom display titles. If no other data files are saved in non-volatile memory, between about 20 and 150 instrument states can be saved (depending on the model type and on instrument parameters). Approximately 14 Mbytes of volatile memory is also available for temporary storage of instrument states, measurement data, screen images, and IBASIC programs.

Disk drive

Trace data, instrument states (including calibration data), and IBASIC programs can be saved on floppy disks using the built-in 3.5 inch disk drive. All files are stored in MS-DOS®-compatible format. Instrument data can be saved in binary or ASCII format (including Touchstone/.s1p format), and screen graphics can be saved as PCX (bit-mapped), HPGL (vector), or PCL5 (printer) files.

NFS

See description under *Controlling via LAN*

Product features, *continued*

Data hardcopy

Hardcopy prints can be made using PCL and PCL5 printers (such as HP DeskJet or LaserJet series printers), or Epson-compatible graphics printers. Single color and multicolor formats are supported. Hardcopy plots can be automatically produced with HPGL-compatible plotters such as the HP 7475A, or with printers that support HPGL. The analyzer provides Centronics (parallel), RS-232C, GPIB, and LAN interfaces.

Automation

Controlling via GPIB Interface

The GPIB interface operates to IEEE 488.2 and SCPI standard-interface commands.

Control

The analyzer can either be the system controller, or pass bus control to another active controller.

Data transfer formats:

- ASCII
- 32- or 64-bit IEEE 754 floating-point format
- Mass-memory-transfer commands allow file transfer between external controller and analyzer.

Controlling via LAN

The built-in LAN interface and firmware support data transfer and control via direct connection to a 10 Base-T (Ethernet) network. A variety of standard protocols are supported, including TCP/IP, sockets, ftp, http, telnet, bootp, and NFS. The LAN interface is standard.

SCPI interface

The analyzer can be controlled by sending SCPI (standard commands for programmable instruments) within a telnet session or via a socket connection and TCP/IP (the default socket port is 5025). The analyzer's socket applications programming interface (API) is compatible with Berkeley sockets, Winsock and other standard socket APIs. Socket programming can be done in a variety of environments including C programs, HP VEE, SICL/LAN, or a Java™ applet. A standard web browser and the analyzer's built-in web page can be used to remotely enter SCPI commands via a Java applet.

FTP interface

Instrument state and data files can be transferred via ftp (file-transfer protocol). An internal, dynamic-data disk provides direct access to instrument states, screen dumps, trace data, and operating parameters.

HTTP

The instrument's built-in web page can be accessed with any standard web browser using http (hypertext transfer protocol) and the network analyzer's IP address. The built-in web page can be used to control the network analyzer, view screen images, download documentation, and link to other sites for firmware upgrades and VXI*plug&play* drivers. Some word processor and spreadsheet programs, such as Microsoft® Word 97 and Excel 97, provide methods to directly import graphics and data via a LAN connection using http and the network analyzer's IP address.

SICL/LAN

The analyzer's support for SICL (standard instrument control library) over the LAN provides control of the network analyzer using a variety of computing platforms, I/O interfaces, and operating systems. With SICL/LAN, the analyzer is controlled remotely over the LAN with the same methods used for a local analyzer connected directly to the computer via a GPIB interface. SICL/LAN protocol also allows the use of Agilent's free VXI*plug&play* driver to communicate with the multiport test system over a LAN. SICL/LAN can be used with Windows 95/98/NT®, or HP-UX.

NFS

The analyzer's built-in NFS (network file system) client provides access to remote files and directories using the LAN. With NFS, remote files and directories (stored remotely on a computer) behave like local files and directories (stored locally within the analyzer). Test data taken by the network analyzer can be saved directly to a remote PC or UNIX® directory, eliminating the need for a remotely initiated ftp session. For Windows-based applications, third-party NFS-server software must be installed on the PC. NFS is fully supported in most versions of UNIX.

Bootp

Bootstrap protocol (bootp) allows a network analyzer to automatically configure itself at power-on with the necessary information to operate on the network. After a bootp request is sent by the analyzer, the host server downloads an IP and gateway address, and a subnet mask. In addition, the analyzer can request an IBASIC file, which automatically executes after the transfer is complete. For Windows-based applications, third-party bootp-server software must be installed on the PC. Bootp is fully supported in most versions of UNIX.

Product features, *continued*

Programming with IBASIC

As a standard feature, all 8712ET/ES and 8714ET/ES network analyzers come with the Instrument BASIC programming language (IBASIC). IBASIC facilitates automated measurements and control of other test equipment, improving productivity. For simpler applications, you can use IBASIC as a keystroke recorder to easily automate manual measurements. Or you can use an optional, standard PC keyboard to write custom test applications that include:

- Special softkey labels
- Tailored user prompts
- Graphical setup diagrams
- Barcode-reading capability
- Control of other test instruments via the GPIB, serial, or parallel interfaces

Measurement calibration

Measurement calibration significantly reduces measurement uncertainty due to errors caused by transmission and reflection frequency response, source and load match, system directivity, and crosstalk. These analyzers feature factory-installed default calibrations that use vector-error correction, so that measurements can be made on many devices without performing a user calibration.

For greater accuracy, especially for test setups with significant loss or reflection, user calibrations should be performed. For reflection measurements, both one-port and two-port calibrations are available (two-port calibration requires an ES model). For transmission measurements, the following calibrations are available: normalization, response, response and isolation, enhanced response, and two port (two-port calibration requires an ES model).

Calibration interpolation

Calibration interpolation is always active. The analyzer automatically recalculates the error coefficients when the test frequencies or the number of trace points have changed. The resulting frequency range must be within the frequency range used during the user calibration. If this is not the case, the analyzer reverts to the factory default calibration. When calibration interpolation is used, the analyzer displays the C? annotation. System performance is not specified for measurements using calibration interpolation.

Available calibrations

ES models only

• **Two-port calibration**

Compensates for frequency response, source and load match, and directivity errors while making S-parameter measurements of transmission (S_{21} , S_{12}) and reflection (S_{11} , S_{22}). Compensates for transmission crosstalk when the Isolation on OFF softkey is toggled to ON. Requires short, open, load, and through standards.

ET and ES models: transmission measurements

• **Normalization**

Provides simultaneous magnitude and phase correction of transmission frequency response errors. Requires a through connection. Used for both narrowband and broadband detection (phase correction is not available in broadband mode). Does not support calibration interpolation.

• **Response**

Simultaneous magnitude and phase correction of frequency response errors for transmission measurements. Requires a through standard.

• **Response and isolation**

Compensates for frequency response and crosstalk errors. Requires a load termination on both test ports and a through standard.

• **Enhanced response**

Compensates for frequency response and source match errors. Requires short, open, load, and through standards.

ET and ES models: reflection measurements

• **One-port calibration**

Compensates for frequency response, directivity, and source match errors. Requires short, open, and load standards.

Calibration kits

Data for several standard calibration kits are stored in the instrument for use by the calibration routines. They include:

- 3.5 mm (85033D)
- type-N 50 ohm (85032B/E)
- type-N 75 ohm (85036B/E)
- type-F 75 ohm (85039B)
- 7 mm (APC-7) (85031B)
- 7-16 (85038A)

In addition, you can also describe the standards for a user-defined kit (for example, open-circuit capacitance coefficients, offset-short length, or through-standard loss).

For more information about calibration kits available from Agilent, consult the 8712E Series Configuration Guide, literature number 5967-6315E.

Product features, *continued*

Key options

75 ohms (Option 1EC)

Provides 75 ohm system impedance.

Step attenuator (Option 1E1)

Adds a built-in 60 dB step attenuator to transmission/reflection (ET) models to extend the output-power range to -60 dBm. The attenuator is standard in S-parameter (ES) models.

Fault location and structural return loss (Option 100)

For fully characterizing cable performance and antenna-feedline systems, this option provides both fault-location and structural-return-loss capability. Fault-location measurements help identify where cable or system faults, such as bends, shorts, or corroded or damaged connectors, occur. In addition to displaying faults in terms of distance into the cable or feedline, the magnitude of the fault is also displayed.

Structural return loss is a special case of return loss (reflection) measurements, optimized for measuring periodic reflections of small magnitude. These periodic reflections can occur from physical damage to the cable caused by rough handling, or from minor imperfections imparted during the manufacturing process. Structural return loss problems occur when these periodic reflections sum at half-wavelength intervals, causing high signal reflection (and low transmission) at the corresponding frequency.

Transport case and fault location and structural return loss (Option 101)

Combines a rugged transport and operation case (part number 08712-60059) with Option 100 for field measurements of fault location and structural return loss.

Test sets

87050E multiport test sets

When used with an 8712E series network analyzer, 87050E multiport test sets provide a complete solution for testing a variety of 50 ohm multiport devices, including multiband filters, signal splitters, and distribution amplifiers. Test sets can be configured with four, eight, or twelve test ports (for more information, please consult the product brochure, literature number 5968-4763E).

87075C multiport test sets

When used with an 8712E series network analyzer, 87075C multiport test sets provide a complete solution for testing 75 ohm multiport devices like CATV distribution amplifiers or multi-taps. Test sets can be configured with six or twelve test ports (for more information, please consult the product brochure, literature number 5968-4766E).

Custom multiport test sets

Besides the standard multiport test sets mentioned above, Agilent can also provide custom multiport test sets. They are available with mechanical or solid-state switches in 50 and 75 ohm versions, in a variety of configurations and connector types. Please contact your sales representative for more information.

For more information about Agilent Technologies test and measurement products, applications, services, and for a current sales office listing, visit our web site:

<http://www.agilent.com/find/tmdir>

You can also contact one of the following centers and ask for a test and measurement sales representative.

United States:

Agilent Technologies
Test and Measurement Call Center
P.O. Box 4026
Englewood, CO 80155-4026
(tel) 1 800 452 4844

Canada:

Agilent Technologies Canada Inc.
5150 Spectrum Way
Mississauga, Ontario, L4W 5G1
(tel) 1 877 894 4414

Europe:

Agilent Technologies
European Marketing Organisation
P.O. Box 999
1180 AZ Amstelveen
The Netherlands
(tel) (31 20) 547 2000

Japan:

Agilent Technologies Japan Ltd.
Measurement Assistance Center
9-1, Takakura-Cho, Hachioji-Shi,
Tokyo 192-8510, Japan
(tel) (81) 426 56 7832
(fax) (81) 426 56 7840

Latin America:

Agilent Technologies
Latin American Region Headquarters
5200 Blue Lagoon Drive, Suite #950
Miami, Florida 33126, U.S.A.
(tel) (305) 267 4245
(fax) (305) 267 4286

Australia/New Zealand:

Agilent Technologies Australia Pty Ltd
347 Burwood Highway
Forest Hill, Victoria 3131
(tel) 1-800 629 485 (Australia)
(fax) (61 3) 9272 0749
(tel) 0 800 738 378 (New Zealand)
(fax) (64 4) 802 6881

Asia Pacific:

Agilent Technologies
24/F, Cityplaza One, 1111 King's Road,
Taikoo Shing, Hong Kong
(tel) (852) 3197 7777
(fax) (852) 2506 9284

Technical data is subject to change

Copyright © 2000

Agilent Technologies

Printed in U.S.A. 3/00

5967-6314E



Agilent Technologies

Innovating the HP Way